

# LOXONE

## Datasheet

LED Pendulum Slim

RGBW Tree

Anthracite

Part No: 100309



### About the product

The LOXONE LED Pendulum Slim RGBW Tree is a pendant light that combines **colored light** and **warm white light**. The **control** and **dimming** takes place directly via the **Tree interface**.

#### Features:

- Timeless, elegant design
- Gentle dimming behavior
- Unique lighting architecture
- Flexible application options

### Electrical Specifications

Supply voltage	21.6 ... 25.2 VDC
Power consumption	Standby: <100mW Red: 1.5W Green: 4.8W Blue: 1W Warm White: 12W max. 12W
Dimming range	0 ... 100%
Frequency	400Hz
Energy efficiency (EU) 2017/1369	F

### Ambient Conditions

Temperature	-40 ... 55°C / -40 ... 131°F
Humidity	max. 95 % RH (non-condensing)

### Interfaces

LOXONE Tree	Connection with Miniserver / Tree Extension
-------------	---

## Connections

Wire cross-section	Connection Cable: 0.75mm <sup>2</sup> / AWG18 Connection Terminals: 0.14 ... 4mm <sup>2</sup> / AWG24 ... 12
Stripping length	Connection Cable: 11mm / 0.43" Connection Terminals: 11mm / 0.43"
Temperature resistance	Connection Cable: max. 70°C / 158°F Connection Terminals: max. 85°C / 185°F

## Connection Diagram

Connection Diagram

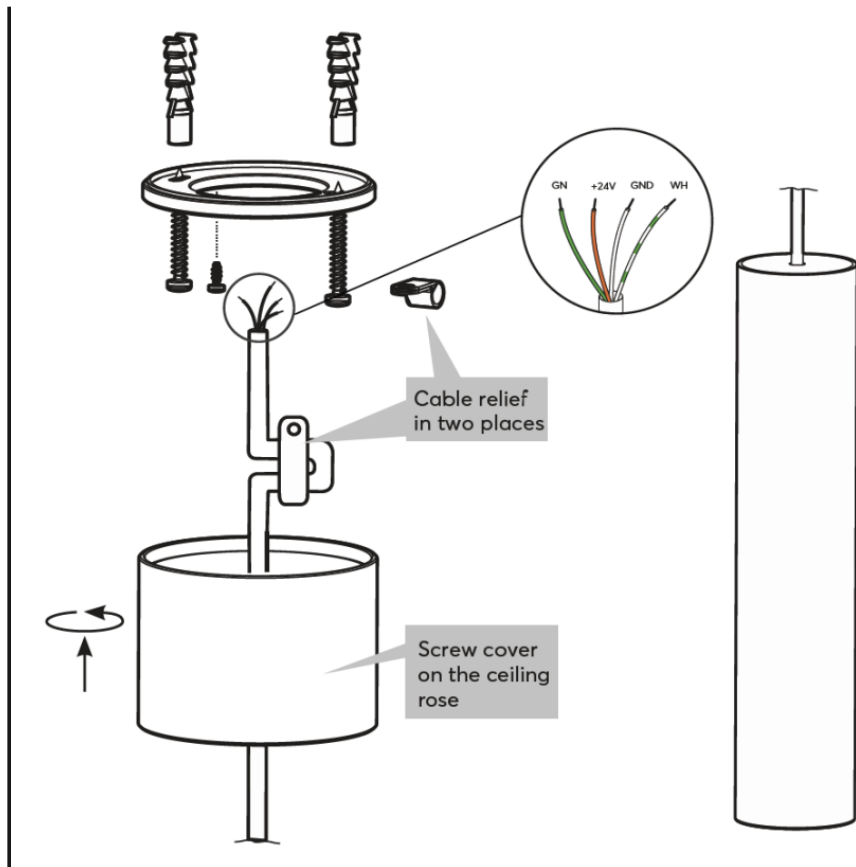

## Light Properties

Colour temperature	typ. 3000k (warm white)
Luminous flux	typ. 975lm (warm white)
Colour rendering index (CRI)	min. 90, (R9 min. 50)
Beam angle	RGB: 120° WW: 38°
Unified glare rating (UGR)	<19

## Product Characteristics

Colours	Anthracite: RAL7021
Material	Steel and Plastic
Finish	Matte
Max. drop from ceiling to lower edge of pendant	2m

## Weight & Dimensions

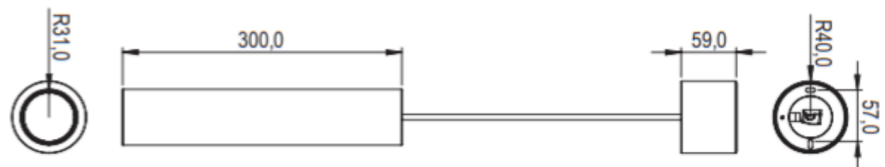

Total weight	1150g
Product dimensions	Luminaire: 300x60mm / 11.81x2.36 (LxD) Baldachin: 60x80mm / 2.36x3.15 (LxD)

Product dimensions drawing



Pack size	394x253x83mm / 15.51x9.96x3.27" (LxWxH)
-----------	---

## Certifications & Standards

Safety class	IP20
Certifications	   

Installation must be carried out by a qualified electrician in accordance with the relevant regulations.

### Published by

Loxone Electronics GmbH  
Smart Home 1  
4154 Kollerschlag  
Austria  
Tel: +43 7287 7070-0  
loxone.com

Loxone UK Ltd.  
The Forum  
Station Road  
Theale, RG7 4RA  
United Kingdom

# Datenblatt

## LED Pendulum Slim RGBW Tree Anthrazit

Part No: 100309



### Über das Produkt

Die LOXONE LED Pendulum Slim RGBW Tree ist eine Pendelleuchte, die **Farblicht** und **warmweißes Licht** kombiniert. Die **Ansteuerung** und das **Dimmen** erfolgen direkt über die **Tree Schnittstelle**.

#### Features:

- Zeitloses, edles Design
- Sanftes Dimmverhalten
- Einzigartige Lichtarchitektur
- Flexible Einsatzmöglichkeiten

### Elektrische Spezifikationen

Versorgungsspannung	21,6 ... 25,2 VDC
Leistungsaufnahme	Standby: <100mW Rot: 1,5W Grün: 4,8W Blau: 1W Warmweiß: 12W max. 12W
Dimmbereich	0 ... 100%
Frequenz	400Hz
Energieeffizienz (EU) 2017/1369	F

### Umgebungsbedingungen

Temperatur	-40 ... 55°C / -40 ... 131°F
Luftfeuchtigkeit	max. 95 % r. F. (nicht kondensierend)

### Schnittstellen

LOXONE Tree	Verbindung mit Miniserver / Tree Extension
-------------	--

## Anschlüsse

Leiterquerschnitt	Anschlussleitung: 0,75mm <sup>2</sup> / AWG18 Anschlussklemmen: 0,14 ... 4mm <sup>2</sup> / AWG24 ... 12
Abisolierlänge	Anschlussleitung: 11mm / 0,43" Anschlussklemmen: 11mm / 0,43"
Temperaturbeständigkeit	Anschlussleitung: max. 70°C / 158°F Anschlussklemmen: max. 85°C / 185°F

## Anschlussplan

Anschlussplan

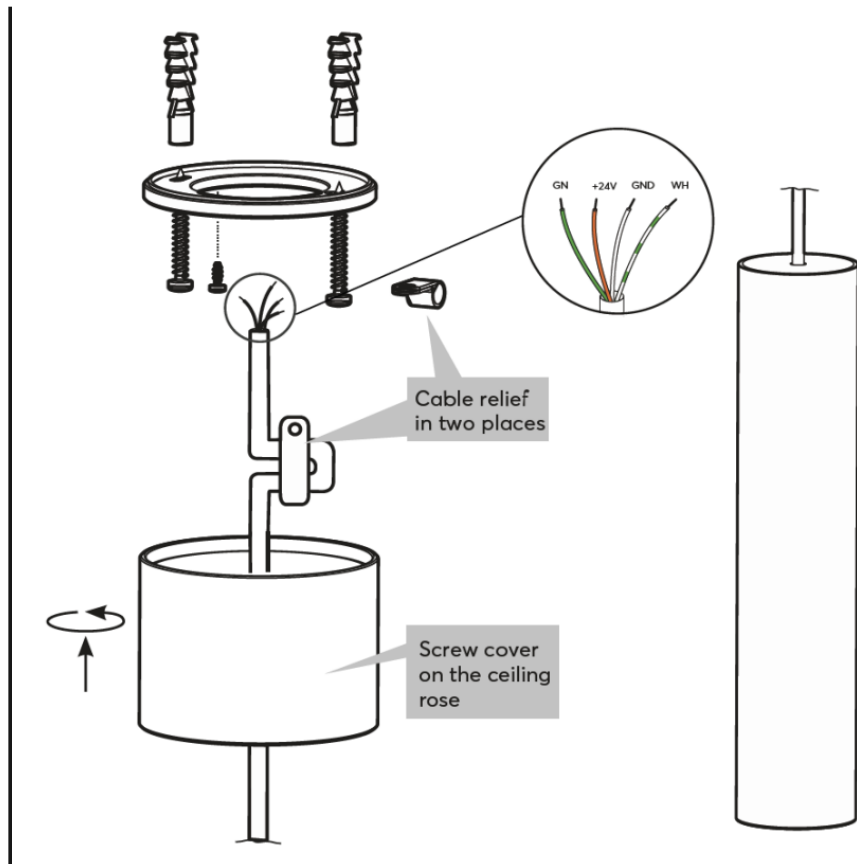

## Lichteigenschaften

Farbtemperatur	typ. 3000k (warmweiß)
Lichtstrom	typ. 975lm (warmweiß)
Farbwiedergabeindex (CRI)	min. 90, (R9 min. 50)
Strahlwinkel	RGB: 120° WW: 38°
Einheitliche Blendungsbewertung (UGR)	<19

## Produkteigenschaften

Farbe	Anthrazit: RAL7021
Material	Stahl und Kunststoff
Glanzgrad	Matt
Max. Abstand von der Decke bis zur Unterkante des Gehäuses	2m

## Gewicht & Abmessungen

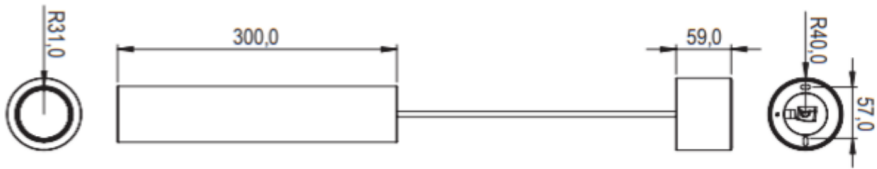
Bruttogewicht	1150g
Produktmaße	Leuchtkörper: 300x60mm / 11,81x2,36 (LxD) Baldachin: 60x80mm / 2,36x3,15 (LxD)
Produktmaßzeichnung	
Packmaß	394x253x83mm / 15.51x9.96x3.27" (LxWxH)

## Zertifizierungen & Standards

Schutzklasse	IP20
Zertifizierungen	

Die Installation muss von einer qualifizierten Elektrofachkraft gemäß den einschlägigen Vorschriften durchgeführt werden.

### Veröffentlicht von

Loxone Electronics GmbH  
Smart Home 1  
4154 Kollerschlag  
Austria  
Tel: +43 7287 7070-0  
loxone.com

Loxone UK Ltd.  
The Forum  
Station Road  
Theale, RG7 4RA  
United Kingdom